

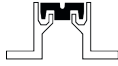

For seismic zone

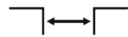

Recess mounted



Joint width 50-1000 mm



Movements in 6 planes



Indoor/
outdoor

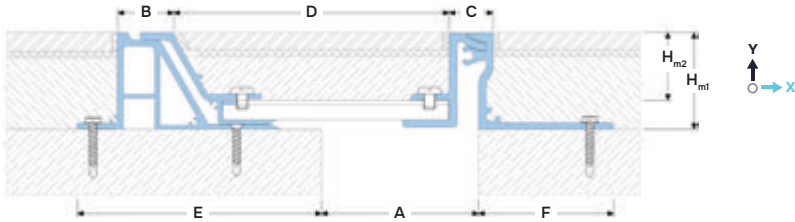

DESIGNATIONS:

- A – nominal joint width;
- B – visible width;
- C – visible width;
- D – middle part width;
- E – min left width seat;
- F – min right width seat;
- H_{m1} – installation height;
- H_{m2} – depth of internal frame;
- M_s – seismic movements;
- M_x – horizontal movements;
- M_y – vertical movements.

Profile	Sizes, mm						Movements, mm			Permissible loads (kN)		
	A ¹	B	C	D	E	F	H _{m1} ⁵	H _{m2}	M _s		M _x	M _y
SV 30-32/50/... ⁵	50	30	23	90 ²	100	75	50, 75, 100	H _{m2} = H _{m1} -18	50 (±25) ³	12 (±6)	-5	pedestrian
SV 30-32/80/... ⁵	80	30	23	140 ²	120	75			80 (±40) ³	12 (±6)	-5	pedestrian
SV 30-32/100/... ⁵	100	30	23	165 ²	125	75			100 (±50) ³	12 (±6)	-7	pedestrian
SV 30-32/150/... ⁵	150	30	23	240 ²	150	75			150 (±75) ³	12 (±6)	-7	pedestrian
SV 30-32/200/... ⁵	200	30	23	315 ²	175	75			200 (±100) ³	12 (±6)	-7	pedestrian
SV 30-32/250/... ⁵	250 ⁴	30	23	390 ²	200	75			250 (±125) ³	12 (±6)	-10	pedestrian
SV 30-32/300/... ⁵	300 ⁴	30	23	465 ²	225	75			300 (±150) ³	12 (±6)	-10	pedestrian
SV 30-32/400/... ⁵	400 ⁴	30	23	615 ²	275	75			400 (±200) ³	12 (±6)	-10	pedestrian
SV 30-32/500/... ⁵	500 ⁴	30	23	765 ²	325	75			500 (±250) ³	12 (±6)	-10	pedestrian

¹ Standard expansion joint width shown. The profile can be made to the required width from 50 to 1000 mm.

² The width of the middle part can be changed to a larger side for ease of installation of the finish coat. This also changes the value of "E".

³ M_s – allowable movements occurring in the event of seismic activity.

⁴ For joints with a width of more than 250 mm subject to loads, it is recommended to reinforce the screed, as well as order special reinforcing bars inserted into the corrugated base plate. Request more information.

⁵... - Standard profile installation height H_{m1}.

► **TECHNICAL DATA**

→ **FRAME**

Material	Aluminum EN AW 6063 T6 (T66 ⁶)
Strength, MPa	σ _b =205 (250 ⁶)
Tolerances	EN 12020-2:2008
Length, m	3,0
Tooling	Perforated holes
Surface coat	Mill finish ⁷
Fasteners	Included

⁶ For EU market.

⁷ The profile can be optionally anodized, stainless steel or brass surface (ask for details).

► **NOTE**

The profile cannot be installed at the X- and T-intersections of expansion joints. Only straight installation is allowed (including L-intersections).

► **CORNER VERSION**

All profiles have corner versions for floor-to-wall connections (joint along the wall). These profiles have an "E" index: SV-E.

Example: SV-E 30-32/100/50

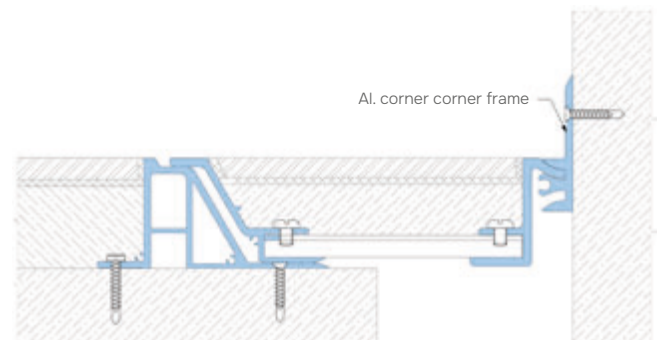

▶ LABELING

(example)

Joint Width

Profile Height

SV 30-32 / 250 / 50

Profile Series:
SV 30-32 – standard version
SV-E 30-32 (marked if required – see “Corner version”)

▶ EQUIPMENT PROFILE

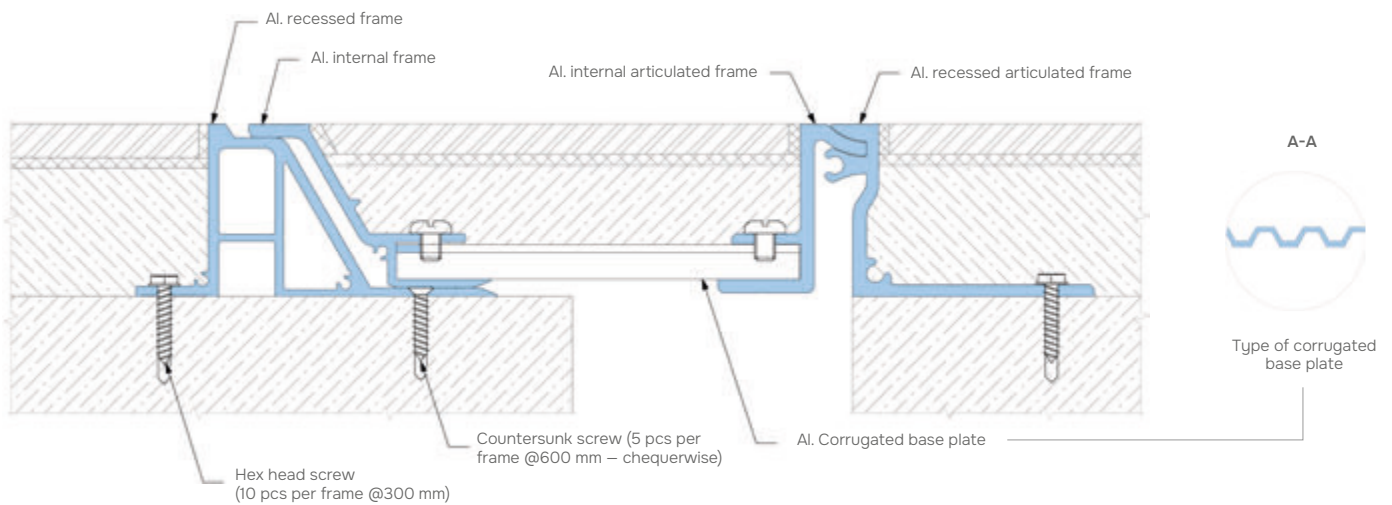

▶ EXECUTION OPTIONS



Using a vapor barrier for waterproofing an expansion joint.

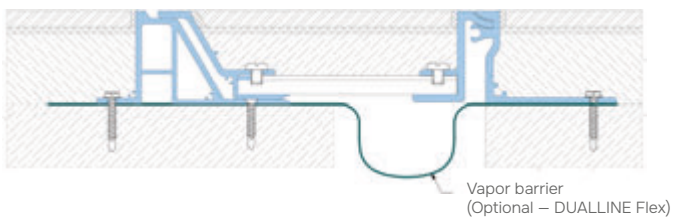

Use of the DUALLINE Standart SV 30-32 profile for installation in floors already finished on one side. Request details.

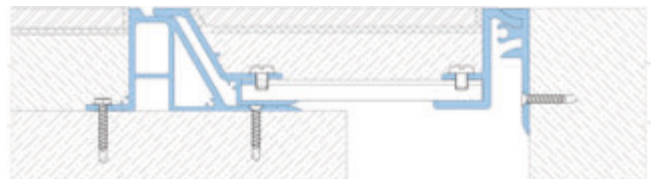

Use of a fire barrier with a fire resistance rating of up to EI 240.

